

# **Technical Specifications**

**Agilent Technologies**  
**PNA Series Network Analyzers**  
**N5230A**  
**Options 140/145/146/240/245/246**  
**(4-Port PNA-L)**



**Manufacturing Part Number: N5230-90020**

**Printed in USA**

**Print Date: November 28, 2006**

**Supersedes: July 11, 2006**

© Agilent Technologies, Inc. 2004 - 2006 All rights reserved.

---

## Documentation Warranty

THE MATERIAL CONTAINED IN THIS DOCUMENT IS PROVIDED "AS IS," AND IS SUBJECT TO BEING CHANGED, WITHOUT NOTICE, IN FUTURE EDITIONS. FURTHER, TO THE MAXIMUM EXTENT PERMITTED BY APPLICABLE LAW, AGILENT DISCLAIMS ALL WARRANTIES, EITHER EXPRESS OR IMPLIED WITH REGARD TO THIS MANUAL AND ANY INFORMATION CONTAINED HEREIN, INCLUDING BUT NOT LIMITED TO THE IMPLIED WARRANTIES OF MERCHANTABILITY AND FITNESS FOR A PARTICULAR PURPOSE. AGILENT SHALL NOT BE LIABLE FOR ERRORS OR FOR INCIDENTAL OR CONSEQUENTIAL DAMAGES IN CONNECTION WITH THE FURNISHING, USE, OR PERFORMANCE OF THIS DOCUMENT OR ANY INFORMATION CONTAINED HEREIN. SHOULD AGILENT AND THE USER HAVE A SEPARATE WRITTEN AGREEMENT WITH WARRANTY TERMS COVERING THE MATERIAL IN THIS DOCUMENT THAT CONFLICT WITH THESE TERMS, THE WARRANTY TERMS IN THE SEPARATE AGREEMENT WILL CONTROL.

---

## DFARS/Restricted Rights Notice

If software is for use in the performance of a U.S. Government prime contract or subcontract, Software is delivered and licensed as "Commercial computer software" as defined in DFAR 252.227-7014 (June 1995), or as a "commercial item" as defined in FAR 2.101(a) or as "Restricted computer software" as defined in FAR 52.227-19 (June 1987) or any equivalent agency regulation or contract clause. Use, duplication or disclosure of Software is subject to Agilent Technologies' standard commercial license terms, and non-DOD Departments and Agencies of the U.S. Government will receive no greater than Restricted Rights as defined in FAR 52.227-19(c)(1-2) (June 1987). U.S. Government users will receive no greater than Limited Rights as defined in FAR 52.227-14 (June 1987) or DFAR 252.227-7015 (b)(2) (November 1995), as applicable in any technical data.

---

## Printing Copies of Documentation from the Web

To print copies of documentation from the Web, download the PDF file from the Agilent web site:

- Go to [www.agilent.com](http://www.agilent.com).
  - Enter the document's part number (located on the title page) in the **Quick Search** box.
  - Click GO.
  - Click on the hyperlink for the document.
  - Click the printer icon located in the tool bar.
-

---

## Contacting Agilent

Assistance with test and measurement needs and information on finding a local Agilent office are available on the Web at:

*[www.agilent.com/find/assist](http://www.agilent.com/find/assist)*

If you do not have access to the Internet, please contact your Agilent field engineer.

---

**NOTE**      In any correspondence or telephone conversation, refer to the Agilent product by its model number and full serial number. With this information, the Agilent representative can determine whether your product is still within its warranty period.

---

---

**This page intentionally left blank.**

---

# Technical Specifications for the N5230A

Options 140/145/146/240/245/246 (4-Port PNA-L) (N5230-90020, Rev. 2006-11-28)

<b>DEFINITIONS</b> .....	<b>3</b>
<b>Corrected System Performance</b> .....	<b>4</b>
<b>Table 1.</b> System Dynamic Range at Test Port .....	<b>4</b>
<b>Table 2.</b> Extended Dynamic Range at Direct Receiver Access Input .....	<b>4</b>
<b>N5230A Corrected System Performance with 3.5mm Connectors</b> .....	<b>5</b>
<b>Table 3.</b> 85052B Calibration Kit N5230A - Option 140 or 145 or 146 or 240 or 245 or 246.....	<b>5</b>
<b>Table 4.</b> N4433A ECal Module N5230A - Option 140 or 145 or 146 or 240 or 245 or 246.....	<b>8</b>
<b>Table 5.</b> Uncorrected System Performance .....	<b>11</b>
<b>Table 6.</b> Test Port Output .....	<b>12</b>
<b>Table 7.</b> Test Port Input.....	<b>14</b>
<b>Table 8.</b> Dynamic Accuracy (Specification) .....	<b>18</b>
<b>Table 9.</b> Test Port Input (Group Delay) .....	<b>24</b>
<b>General Information</b> .....	<b>25</b>
<b>Table 10.</b> Miscellaneous Information .....	<b>25</b>
<b>Table 11.</b> Front Panel Information.....	<b>25</b>
<b>Table 12.</b> Rear Panel Information .....	<b>26</b>
<b>Table 13.</b> Analyzer Environment and Dimensions .....	<b>27</b>
<b>Measurement Throughput Summary</b> .....	<b>28</b>
<b>Table 14</b> Typical Cycle Time (ms) for Measurement Completion.....	<b>28</b>
<b>Table 15.</b> Cycle Time vs IF Bandwidth .....	<b>29</b>
<b>Table 16.</b> Cycle Time vs Number of Points.....	<b>30</b>
<b>Table 17.</b> Data Transfer Time (ms).....	<b>31</b>
<b>Specifications: Front-Panel Jumpers</b> .....	<b>32</b>
<b>Table 18:</b> Measurement Receiver Inputs (Rcvr A In, Rcvr B In, Rcvr C In, Rcvr D In) 0.1dB Typical Compression .....	<b>32</b>
<b>Table 19:</b> Reference Receiver Input (Rcvr In) @ Max Specified Output Power .....	<b>32</b>
<b>Table 20:</b> Reference Output (Source Out) @ Max Specified Output Power .....	<b>33</b>
<b>Table 21:</b> Source Outputs (Port 1 Source Out, Port 2 Source Out, Port 3 Source Out, Port 4 Source Out) @ Max Specified Output Power.....	<b>33</b>
<b>Table 22:</b> Coupler Inputs (Port 1 Cplr Thru, Port 2 Cplr Thru, Port 3 Cplr Thru, Port 4 Cplr Thru) Insertion Loss of Coupler Thru.....	<b>34</b>
<b>Table 23:</b> Coupler Outputs (Port 1 Cplr Arm, Port 2 Cplr Arm, Port 3 Cplr Arm, Port 4 Cplr Arm).....	<b>34</b>
<b>Test Set Block Diagrams</b> .....	<b>35</b>
N5230A Option 140 or 240 (Standard Test Set and Standard Power Range).....	<b>35</b>
N5230A Option 145 or 245 (Configurable Test Set and Extended Power Range).....	<b>36</b>
N5230A Option 146 or 246 (Configurable Test Set, Extd Pwr Range, Second Source).....	<b>37</b>

This page is intentionally blank.

This is a complete list of the N5230A Options 140, 145, 146, 240, 245, 246 network analyzer technical specifications.

- To view or print the .pdf version of the specifications, visit our web site at <http://www.agilent.com/find/pna>, and search for "N5230A Options 140 or 145 or 146 or 240 or 245 or 246 Specifications"
- This N5230A document provides technical specifications for the 85052B calibration kit and the N4433A ECal module. Please download our free Uncertainty Calculator from [http://www.agilent.com/find/na\\_calculator](http://www.agilent.com/find/na_calculator) to generate the curves for your calibration kit and PNA setup.

---

## Definitions

All specifications and characteristics apply over a 25 °C  $\pm$ 5 °C range (unless otherwise stated) and 90 minutes after the instrument has been turned on.

**Specification (spec.):** Warranted performance. Specifications include guardbands to account for the expected statistical performance distribution, measurement uncertainties, and changes in performance due to environmental conditions.

**Characteristic (char.):** A performance parameter that the product is expected to meet before it leaves the factory, but that is not verified in the field and is not covered by the product warranty. A characteristic includes the same guardbands as a specification.

**Typical (typ.):** Expected performance of an average unit which does not include guardbands. It is not covered by the product warranty.

**Nominal (nom.):** A general, descriptive term that does not imply a level of performance. It is not covered by the product warranty.

**Calibration:** The process of measuring known standards to characterize a network analyzer's systematic (repeatable) errors.

**Corrected (residual):** Indicates performance after **error correction** (calibration). It is determined by the quality of calibration standards and how well "known" they are, plus system repeatability, stability, and noise.

**Uncorrected (raw):** Indicates instrument performance without error correction. The uncorrected performance affects the stability of a **calibration**.

**Standard:** When referring to the analyzer, this includes no options unless noted otherwise.

## Corrected System Performance

The specifications in this section apply for measurements made with the N5230A analyzer with the following conditions:

- 10 Hz IF bandwidth
- No averaging applied to data
- Isolation calibration with an averaging factor of 8

**Table 1. System Dynamic Range at Test Port<sup>1</sup>**

Description	Specification (dB) at Test Port	Typical (dB) at Test Port
<b>Standard configuration and standard power range (Option 140/240)</b>		
300 KHz to 10 MHz <sup>2</sup>	--	108 dB
10 MHz to 4 GHz <sup>2</sup>	120 dB	128 dB
4 GHz to 6 GHz	118 dB	129 dB
6 GHz to 10.5 GHz	115 dB	127 dB
10.5 GHz to 13.5 GHz	107 dB	119 dB
13.5 GHz to 15 GHz	107 dB	119 dB
15 GHz to 20 GHz	103 dB	116 dB
<b>Configurable test set and extended power range (Option 145/245)</b>		
<b>Configurable test set, extended power range and internal second source (Option 146/246)</b>		
300 KHz to 10 MHz <sup>2</sup>	--	108 dB
10 MHz to 4 GHz <sup>2</sup>	120 dB	128 dB
4 GHz to 6 GHz	118 dB	128 dB
6 GHz to 10.5 GHz	113 dB	125 dB
10.5 GHz to 13.5 GHz	105 dB	117 dB
13.5 GHz to 15 GHz	105 dB	117 dB
15 GHz to 20 GHz	98 dB	115 dB

<sup>1</sup> The system dynamic range is calculated as the difference between the noise floor and the specified source maximum output power. The effective dynamic range must take measurement uncertainties and interfering signals into account.

<sup>2</sup> May be degraded by 10 dB at particular frequencies (multiples of 5 MHz) below 500 MHz due to spurious receiver residuals. Methods are available to regain the full dynamic range.

**Table 2. Extended Dynamic Range at Direct Receiver Access Input<sup>1</sup>**

<b>Configurable test set and extended power range (Options 145/245)</b>		
<b>Configurable test set, extended power range and internal second source (Options 146/246)</b>		
	Specification (dB)	Typical (dB)
300 KHz to 10 MHz <sup>2</sup>	--	124 dB
10 MHz to 4 GHz <sup>2</sup>	136 dB	--
4 GHz to 6 GHz	134 dB	--
6 GHz to 10.5 GHz	129 dB	--
10.5 GHz to 13.5 GHz	121 dB	--
13.5 GHz to 15 GHz	121 dB	--
15 GHz to 20 GHz	114 dB	--

<sup>1</sup> The direct receiver access input extended dynamic range is calculated as the difference between the direct receiver access input noise floor and the source maximum output power. The effective dynamic range must take measurement uncertainties and interfering signals into account. This set-up should only be used when the receiver input will never exceed its compression or damage level. When the analyzer is in segment sweep mode, it can have predefined frequency segments which will output a higher power level when the extended dynamic range is required (i.e. devices with high insertion loss), and reduced power when receiver compression or damage may occur (i.e. devices with low insertion loss). The extended range is only available in one-path transmission measurements.

<sup>2</sup> May be degraded by 10 dB at particular frequencies (multiples of 5 MHz) below 500 MHz due to spurious receiver residuals. Methods are available to regain the full dynamic range.

*Receiver Dynamic Range technical specifications are not provided in this N5230A specs document.*



## N5230A Corrected System Performance with 3.5mm Connectors<sup>1</sup>

### Option 140 or 145 or 146 or 240 or 245 or 246

<sup>1</sup> From 300 kHz to 10 MHz, performance is characterized as "typical". To generate these typical values, please download our free Uncertainty Calculator from [http://www.agilent.com/find/na\\_calculator](http://www.agilent.com/find/na_calculator).

**Note:** For any  $S_{ii}$  reflection measurement:

- $S_{ii} = 0$ .

For any  $S_{ij}$  transmission measurement:

- $S_{ji} = S_{ij}$  when  $S_{ij} \leq 1$
- $S_{ji} = 1/S_{ij}$  when  $S_{ij} \geq 1$
- $S_{kk} = 0$  for all k

### Table 3. 85052B Calibration Kit

N5230A - Option 140 or 240 (Standard Test Set and Standard Power Range), Option 145 or 245 (Configurable Test Set and Extended Power Range), Option 146 or 246 (Configurable Test Set and Extended Power Range with Internal Second Source)

Applies to the N5230A Option 140 or 145 or 146 or 240 or 245 or 246 analyzers, 85052B (3.5mm) calibration kit, 85131F flexible test port cable set, and a full 4-port calibration. Also applies to the following condition:

Environmental temperature  $23^{\circ} \pm 3^{\circ} \text{C}$ , with  $< 1^{\circ} \text{C}$  deviation from calibration temperature

Description	Specification (dB)				
	10 MHz to 500 MHz	500 MHz to 2 GHz	2 to 8 GHz	8 to 13.5 GHz	13.5 to 20 GHz
Directivity	48	48	44	44	44
Source Match	40	40	33	31	31
Load Match	48	48	44	44	44
Reflection Tracking	$\pm 0.003$ $+0.010/^{\circ}\text{C}$	$\pm 0.003$ $+0.010/^{\circ}\text{C}$	$\pm 0.003$ $+0.020/^{\circ}\text{C}$	$\pm 0.006$ $+0.030/^{\circ}\text{C}$	$\pm 0.006$ $+0.030/^{\circ}\text{C}$
Transmission Tracking	$\pm 0.017$ $+0.010/^{\circ}\text{C}$	$\pm 0.017$ $+0.010/^{\circ}\text{C}$	$\pm 0.062$ $+0.020/^{\circ}\text{C}$	$\pm 0.125$ $+0.030/^{\circ}\text{C}$	$\pm 0.125$ $+0.030/^{\circ}\text{C}$

## Transmission Uncertainty (Specifications)

### Magnitude

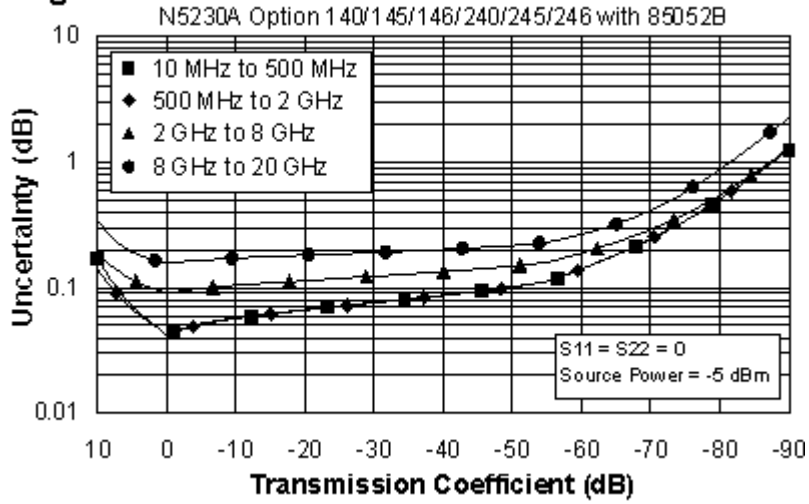

### Phase

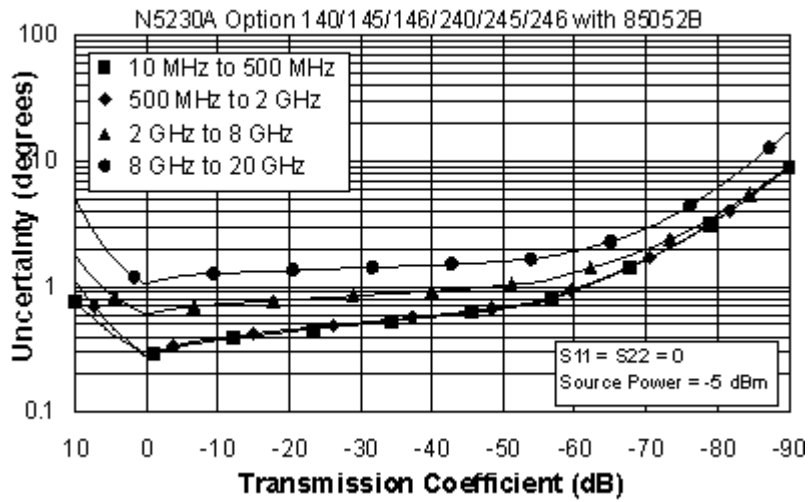

## Reflection Uncertainty (Specifications)

### Magnitude

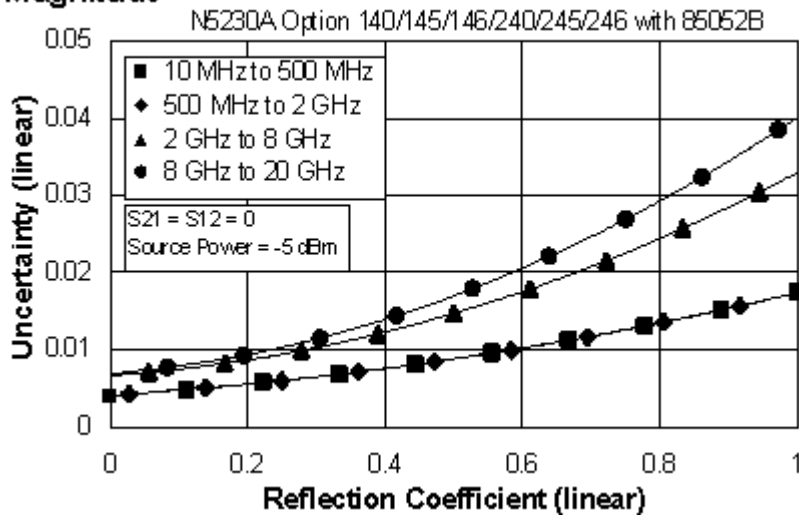

### Phase

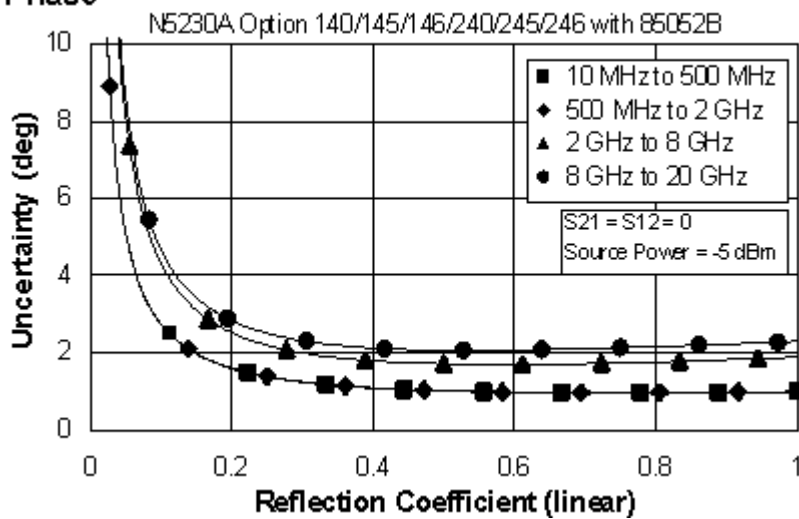

**Table 4. N4433A Electronic Calibration Module  
N5230A - Option 140 or 240 (Standard Test Set and Standard Power Range), Option 145 or 245  
(Configurable Test Set and Extended Power Range), Option 146 or 246 (Configurable  
Test Set and Extended Power Range with Internal Second Source)**

Applies to the, N5230A Option 140 or 145 or 146 or 240 or 245 or 246 analyzers, N4433A (3.5mm) electronic calibration module, 85131F flexible test port cable set, and a full 4-port calibration. Also applies to the following condition:

Environmental temperature  $23^{\circ} \pm 3^{\circ} \text{C}$ , with  $< 1^{\circ} \text{C}$  deviation from calibration temperature

Description	Specification (dB)				
	10 MHz to 500 MHz	500 MHz to 2 GHz	2 to 8 GHz	8 to 13.5 GHz	13.5 to 20 GHz
Directivity	52	52	47	45	45
Source Match	42	42	39	31	31
Load Match	45	45	41	35	35
Reflection Tracking	$\pm 0.060$ $+0.010/^{\circ}\text{C}$	$\pm 0.060$ $+0.010/^{\circ}\text{C}$	$\pm 0.090$ $+0.020/^{\circ}\text{C}$	$\pm 0.180$ $+0.030/^{\circ}\text{C}$	$\pm 0.180$ $+0.030/^{\circ}\text{C}$
Transmission Tracking	$\pm 0.045$ $+0.010/^{\circ}\text{C}$	$\pm 0.039$ $+0.010/^{\circ}\text{C}$	$\pm 0.055$ $+0.020/^{\circ}\text{C}$	$\pm 0.160$ $+0.030/^{\circ}\text{C}$	$\pm 0.160$ $+0.030/^{\circ}\text{C}$

## Transmission Uncertainty (Specifications)

### Magnitude

N5230A Option 140/145/146/240/245/246 Full Two Port Cal Using N4433A

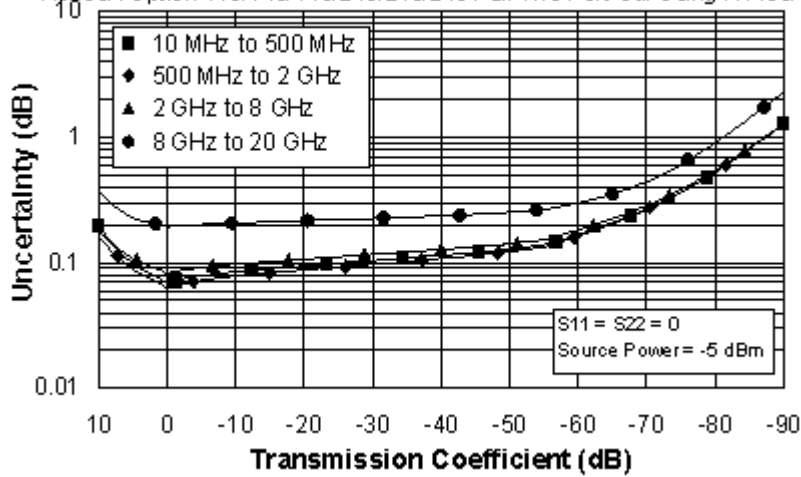

### Phase

N5230A Option 140/145/146/240/245/246 Full Two Port Cal Using N4433A

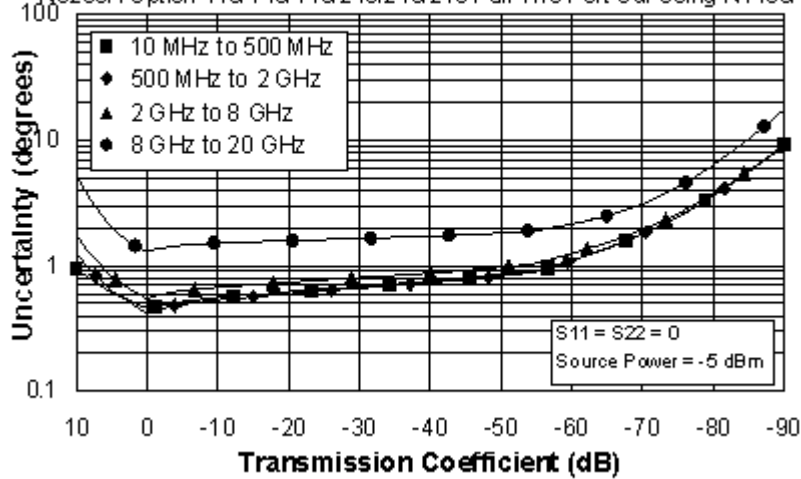

## Reflection Uncertainty (Specifications)

### Magnitude

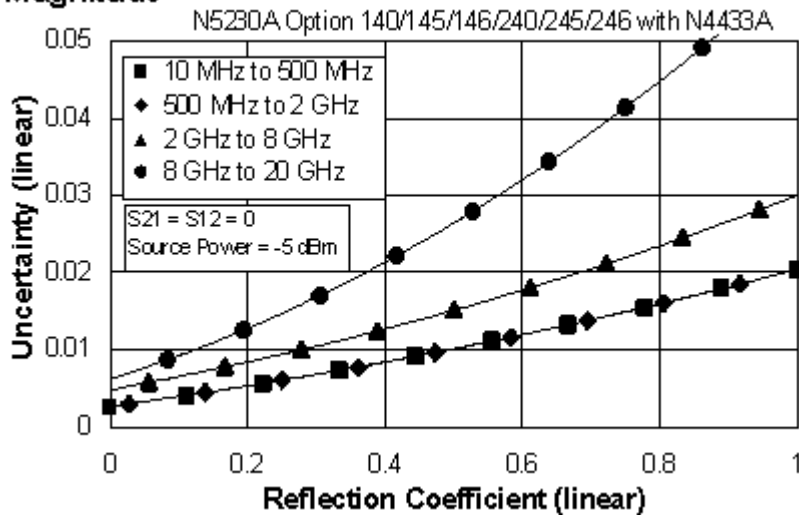

### Phase

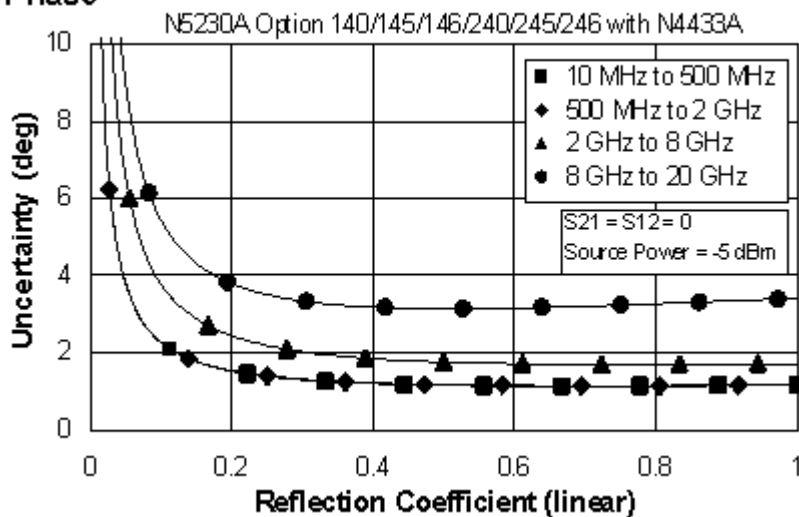

This N5230A document does not present specifications for the 85052C or 85052D Calibration Kit. Please download our free Uncertainty Calculator from [http://www.agilent.com/find/na\\_calculator](http://www.agilent.com/find/na_calculator) to generate the data and curves for the 85052C or the 85052D Calibration Kit. View the [equations](#) used to generate the uncertainty curves.

**Table 5. Uncorrected System Performance<sup>1</sup>**

<b>Description</b>	<b>Specification</b>	<b>Typical</b>
	<b>Options 140/145/146/240/245/246</b>	<b>Options 140/145/146/240/245/246</b>
<b>Directivity</b>		
300 KHz to 10 MHz	--	-23 dB
10 MHz to 1 GHz	-28 dB	--
1 GHz to 3 GHz	-25 dB	--
3 GHz to 5 GHz	-20 dB	--
5 GHz to 11.5 GHz	-17 dB	--
11.5 GHz to 13.5 GHz	-15 dB	--
13.5 GHz to 20 GHz	-15 dB	--
<b>Source Match</b>		
300 KHz to 10 MHz	--	-8 dB
10 MHz to 1 GHz	-12 dB	--
1 GHz to 3 GHz	-12 dB	--
3 GHz to 5 GHz	-12 dB	--
5 GHz to 10.5 GHz	-12 dB	--
10.5 GHz to 11.5 GHz	-10 dB	--
11.5 GHz to 13.5 GHz	-8 dB	--
13.5 GHz to 20 GHz	-8 dB	--
<b>Load Match</b>		
300 KHz to 10 MHz	--	-9 dB
10 MHz to 1 GHz	-20 dB	--
1 GHz to 3 GHz	-20 dB	--
3 GHz to 5 GHz	-18 dB	--
5 GHz to 11.5 GHz	-12 dB	--
11.5 GHz to 13.5 GHz	-7 dB	--
13.5 GHz to 16 GHz	-7 dB	--
16 GHz to 20 GHz	-7.5 dB	--
<b>Crosstalk<sup>2</sup></b>		
300 KHz to 5 MHz	--	-70 dB
5 MHz to 10 MHz	--	-100 dB
10 MHz to 45 MHz	--	-110 dB
45 MHz to 4 GHz	--	-122 dB
4 GHz to 6 GHz	--	-123 dB
6 GHz to 10.5 GHz	--	-120 dB
10.5 GHz to 13.5 GHz	--	-115 dB
13.5 GHz to 15 GHz	--	-115 dB
15 GHz to 20 GHz	--	-110 dB

<sup>1</sup> Specifications apply over environmental temperature of 25 °C ±5 °C, with less than 1°C variation from the calibration temperature.

<sup>2</sup> Measurement conditions: normalized to a thru, measured with two shorts, 10 Hz IF bandwidth, averaging factor of 8, alternate mode, source power set to the lesser of the maximum power-out or the maximum receiver power.

**Table 6. Test Port Output<sup>1</sup>**

Description	Specification		Typical	
	Options 140/240	Opt 145/146/245/246	Options 140/240	Opt 145/146/245/246
<b>Frequency Range</b>				
Options 140/145/146	300 KHz to 13.5 GHz		--	
Options 240/245/246	300 KHz to 20 GHz		--	
<b>Nominal Power</b>				
	-5 dBm	-8 dBm	Preset power; attenuator switch point 10 dB below nominal power	
<b>Frequency Resolution</b>				
	1 Hz		--	
<b>CW Accuracy</b>				
	+/-1 ppm		--	
<b>Frequency Stability</b>				
	--		+/-0.05 ppm, -10° to 70° C +/-0.1 ppm/yr maximum	
Description	Specification		Typical	
	Options 140/240	Opt 145/146/245/246	Options 140/240	Opt 145/146/245/246
<b>Power Level Accuracy</b>				
Variation from nominal power in range 0				
300 KHz to 10 MHz	--	--	+/-1.0 dB	+/-1.0 dB
10 MHz to 2 GHz	+/-1.0 dB	+/-1.0 dB	--	--
2 GHz to 10.5 GHz	+/-1.5 dB	+/-1.5 dB	--	--
10.5 GHz to 13.5 GHz	+/-2.5 dB	+/-2.5 dB	--	--
13.5 GHz to 20 GHz	+/-2.5 dB	+/-2.5 dB	--	--
<b>Max Leveled Power</b>				
300 KHz to 10 MHz	--	--	+5 dBm	+5 dBm
10 MHz to 4 GHz	+8 dBm	+8 dBm	+12 dBm	+11 dBm
4 GHz to 6 GHz	+6 dBm	+6 dBm	+10 dBm	+9 dBm
6 GHz to 10.5 GHz	+3 dBm	+1 dBm	+8 dBm	+6 dBm
10.5 GHz to 13.5 GHz	0 dBm	-2 dBm	+5 dBm	+3 dBm
13.5 GHz to 15 GHz	0 dBm	-2 dBm	+5 dBm	+3 dBm
15 GHz to 20 GHz	-3 dBm	-8 dBm	+2 dBm	-1 dBm
<b>Power Level Linearity</b>				
Refer to footnote 1.				
300 KHz to 10 MHz	--	--	+/-2.0 dB	+/-2.0 dB
10 MHz to 1 GHz	+/-2.0 dB	+/-2.0 dB	--	--
1 GHz to 13.5 GHz	+/-1.5 dB	+/-1.5 dB	--	--
13.5 GHz to 20 GHz	+/-1.5 dB	+/-1.5 dB	--	--
<b>Power Sweep Range (ALC)</b>				
ALC range starts at maximum-leveled power and decreases by the dB amount specified here.				
300 KHz to 10 MHz	--	--	32 dB	32 dB
10 MHz to 4 GHz	33 dB	33 dB	--	--
4 GHz to 6 GHz	31 dB	31 dB	--	--
6 GHz to 10.5 GHz	28 dB	26 dB	--	--
10.5 GHz to 13.5 GHz	25 dB	23 dB	--	--
13.5 GHz to 15 GHz	25 dB	23 dB	--	--
15 GHz to 20 GHz	22 dB	17 dB	--	--



**Table 6. Test Port Output (Continued)**

Description	Specification		Typical	
	Options 140/240	Opt 145/146/245/246	Options 140/240	Opt 145/146/245/246
<b>Power Resolution</b>				
	0.01 dB	0.01 dB	--	--
<b>Power Range</b>				
300 KHz to 10 MHz	--	--	-27 to +5 dBm	-87 to +5 dBm
10 MHz to 45MHz	--	--	-27 to +12 dBm	-87 to +11 dBm
45 MHz to 4 GHz	--	--	-27 to +12 dBm	-87 to +11 dBm
4 GHz to 6 GHz	--	--	-27 to +10 dBm	-87 to +9 dBm
6 GHz to 10.5 GHz	--	--	-27 to +8 dBm	-87 to +6 dBm
10.5 GHz to 13.5 GHz	--	--	-27 to +5 dBm	-87 to +3 dBm
13.5 GHz to 15 GHz	--	--	-27 to +5 dBm	-87 to +3 dBm
15 GHz to 20 GHz	--	--	-27 to +2 dBm	-87 to -1 dBm
<b>Power Settings</b>				
Minimum Power Setting	--	--	-30 dBm	-90 dBm
Maximum Power Setting	--	--	+20 dBm	+20 dBm
<b>Harmonics (2nd or 3rd) at Maximum Output Power</b>				
In-band Source Harmonics				
300 KHz to 10 MHz	--	--	-17 dBc	
10 MHz to 1 GHz	--	--	-17 dBc	
1 GHz to 13.5 GHz	--	--	-20 dBc	
13.5 GHz to 20 GHz	--	--	-20 dBc	
<b>Non-Harmonic Spurious (at Nominal Output Power)</b>				
300 KHz to 13.5 GHz	--	--	-50 dBc for offset frequency > 1 KHz	
13.5 GHz to 20 GHz	--	--	-50 dBc for offset frequency > 1 KHz	

<sup>1</sup> For Options 140/145/240/245, performance is specified on Port 1 only; Ports 2, 3, and 4 performance is typical. For Options 146/246, performance is specified on Ports 1 and 3 only; Ports 2 and 4 performance is typical. Test reference is at the nominal power level.

**Table 6. Test Port Output (Continued)**

Phase Noise (Nominal power at test port)	Typical Performance		
	Options 140/145/146/240/245/246		
	10 kHz Offset	100 kHz Offset	1 MHz Offset
300 KHz to 10 MHz	-86 dBc/Hz	-86 dBc/Hz	-95 dBc/Hz
10 MHz to 1.5 GHz	-86 dBc/Hz	-91 dBc/Hz	-95 dBc/Hz
1.5 GHz to 3.125 GHz	-83 dBc/Hz	-91 dBc/Hz	-95 dBc/Hz
3.125 GHz to 6.25 GHz	-77 dBc/Hz	-85 dBc/Hz	-89 dBc/Hz
6.25 GHz to 12.5 GHz	-71 dBc/Hz	-79 dBc/Hz	-83 dBc/Hz
12.5 GHz to 13.5 GHz	-65 dBc/Hz	-73 dBc/Hz	-77 dBc/Hz
13.5 GHz to 20 GHz	-65 dBc/Hz	-73 dBc/Hz	-77 dBc/Hz

**Table 7. Test Port Input**

Description	Specification		Typical	
	Options 140/145/146/240/245/246		Options 140/145/146/240/245/246	
<b>Test Port Noise Floor</b>				
Total average (rms) noise power calculated as the mean value of a linear magnitude trace expressed in dBm.				
<b>10 Hz IF Bandwidth</b>				
300 KHz to 10 MHz	--		<-103 dBm	
10 MHz to 500 MHz	<-112 dBm		<-116 dBm	
500 MHz to 4 GHz	<-112 dBm		<-120 dBm	
4 GHz to 10.5 GHz	<-112 dBm		<-119 dBm	
10.5 GHz to 13.5 GHz	<-107 dBm		<-114 dBm	
13.5 GHz to 15 GHz	<-107 dBm		<-114 dBm	
15 GHz to 20 GHz	<-106 dBm		<-114 dBm	
<b>1 KHz IF Bandwidth</b>				
300 KHz to 10 MHz	--		<-83 dBm	
10 MHz to 500 MHz	<-92 dBm		<-96 dBm	
500 MHz to 4 GHz	<-92 dBm		<-100 dBm	
4 GHz to 10.5 GHz	<-92 dBm		<-99 dBm	
10.5 GHz to 13.5 GHz	<-87 dBm		<-94 dBm	
13.5 GHz to 15 GHz	<-87 dBm		<-94 dBm	
15 GHz to 20 GHz	<-86 dBm		<-94 dBm	
<b>Direct Receiver Access Input Noise Floor (Options 145/146/245/246)</b>				
Total average (rms) noise power calculated as the mean value of a linear magnitude trace expressed in dBm.				
<b>10 Hz IF Bandwidth</b>				
300 KHz to 10 MHz	--		<-119 dBm	
10 MHz to 500 MHz	<-128 dBm		<-132 dBm	
500 MHz to 4 GHz	<-128 dBm		<-136 dBm	
4 GHz to 10.5 GHz	<-128 dBm		<-135 dBm	
10.5 GHz to 13.5 GHz	<-123 dBm		<-130 dBm	
13.5 GHz to 15 GHz	<-123 dBm		<-130 dBm	
15 GHz to 20 GHz	<-122 dBm		<-130 dBm	
<b>1 KHz IF Bandwidth</b>				
300 KHz to 10 MHz	--		<-99 dBm	
10 MHz to 500 MHz	<-108 dBm		<-112 dBm	
500 MHz to 4 GHz	<-108 dBm		<-116 dBm	
4 GHz to 10.5 GHz	<-108 dBm		<-115 dBm	
10.5 GHz to 13.5 GHz	<-103 dBm		<-110 dBm	
13.5 GHz to 15 GHz	<-103 dBm		<-110 dBm	
15 GHz to 20 GHz	<-102 dBm		<-110 dBm	
Description	Specification		Typical	
	Options 140/145/146/240/245/246		Options 140/145/146/240/245/246	
<b>Compression Level (at +8 dBm except as noted)</b>				
	Power	Compression	Power	Compression
300 KHz to 10 MHz	--	--	+5 dBm	0.10 dB
10 MHz to 50 MHz	+8 dBm	0.35 dB	--	--
50 MHz to 1 GHz	+8 dBm	0.35 dB	--	--
1 GHz to 8 GHz	+8 dBm	0.25 dB	--	--
8 GHz to 12.5 GHz	+8 dBm	0.30 dB	--	--
12.5 GHz to 13.5 GHz	+8 dBm	0.55 dB	--	--
13.5 GHz to 20 GHz	+8 dBm	0.55 dB	--	--

Table 7. Test Port Input (Continued)				
Description	Specification		Typical	
	Options 140/145/146/240/245/246		Options 140/145/146/240/245/246	
<b>Test Port Compression – 0.1 dB</b>				
	Power	Compression	Power	Compression
300 KHz to 10 MHz	--	--	+5 dBm	--
10 MHz to 1 GHz	--	--	+9 dBm	--
1 GHz to 12.5 GHz	--	--	+10 dBm	--
12.5 GHz to 13.5 GHz	--	--	+9 dBm	--
13.5 GHz to 20 GHz	--	--	+9 dBm	--

Table 7. Test Port Input (Continued)						
Description	Specification			Typical		
	Options 140/240	Option 145/245	Options 146/246	Options 140/240	Options 145/245	Options 146/246
<b>Trace Noise Magnitude</b>						
Ratioed measurement, nominal power at test port.						
<b>100 KHz IF bandwidth</b>						
300 KHz to 10 MHz	--	--	--	.015 dB rms	.030 dB rms	.050 dB rms
10 MHz to 10.5 GHz	.006 dB rms	.008 dB rms	.016 dB rms	.004 dB rms	.005 dB rms	.013 dB rms
10.5 GHz to 13.5 GHz	.010 dB rms	.014 dB rms	.038 dB rms	.007 dB rms	.009 dB rms	.026 dB rms
13.5 GHz to 20 GHz	.010 dB rms	.014 dB rms	.038 dB rms	.007 dB rms	.009 dB rms	.026 dB rms
<b>600 KHz IF bandwidth</b>						
300 KHz to 10 MHz	--	--	--	.015 dB rms	.030 dB rms	.050 dB rms
10 MHz to 10.5 GHz	--	--	--	.013 dB rms	.015 dB rms	.032 dB rms
10.5 GHz to 13.5 GHz	--	--	--	.017 dB rms	.023 dB rms	.063 dB rms
13.5 GHz to 20 GHz	--	--	--	.017 dB rms	.023 dB rms	.063 dB rms
<b>100 KHz IF bandwidth</b>						
Measured at Maximum Specified Power						
300 KHz to 10 MHz	--	--	--	.005 dB rms	.010 dB rms	.012 dB rms
10 MHz to 2 GHz	--	--	--	.001 dB rms	.003 dB rms	.004 dB rms
2 GHz to 10.5 GHz	--	--	--	.002 dB rms	.003 dB rms	.004 dB rms
10.5 GHz to 13.5 GHz	--	--	--	.006 dB rms	.009 dB rms	.023 dB rms
13.5 GHz to 20 GHz	--	--	--	.006 dB rms	.009 dB rms	.023 dB rms

<b>Table 7. Test Port Input (Continued)</b>						
<b>Description</b>	<b>Specification</b>			<b>Typical</b>		
	<b>Options 140/240</b>	<b>Options 145/245</b>	<b>Options 146/246</b>	<b>Options 140/240</b>	<b>Options 145/245</b>	<b>Option 146/246</b>
<b>Trace Noise Phase</b>						
Ratioed measurement, nominal power at test port.						
<b>100 KHz IF bandwidth</b>						
300 KHz to 10 MHz	--	--	--	0.110 deg rms	0.180 deg rms	0.280 deg rms
10 MHz to 10.5 GHz	0.05 deg rms	0.07 deg rms	0.13 deg rms	0.025 deg rms	0.035 deg rms	0.090 deg rms
10.5 GHz to 13.5 GHz	0.08 deg rms	0.10 deg rms	0.250 deg rms	0.050 deg rms	0.060 deg rms	0.170 deg rms
13.5 GHz to 20 GHz	0.08 deg rms	0.10 deg rms	0.250 deg rms	0.050 deg rms	0.060 deg rms	0.170 deg rms
<b>600 KHz IF bandwidth</b>						
300 KHz to 10 MHz	--	--	--	0.110 deg rms	0.180 deg rms	0.300 deg rms
10 MHz to 10.5 GHz	--	--	--	0.080 deg rms	0.100 deg rms	0.200 deg rms
10.5 GHz to 13.5 GHz	--	--	--	0.120 deg rms	0.160 deg rms	0.430 deg rms
13.5 GHz to 20 GHz	--	--	--	0.120 deg rms	0.160 deg rms	0.430 deg rms
<b>100 KHz IF bandwidth</b>						
Measured at Maximum Specified Power						
300 KHz to 10 MHz	--	--	--	0.040 deg rms	0.050 deg rms	0.075 deg rms
10 MHz to 2 GHz	--	--	--	0.007 deg rms	0.012 deg rms	0.013 deg rms
2 GHz to 10.5 GHz	--	--	--	0.012 deg rms	0.015 deg rms	0.030 deg rms
10.5 GHz to 13.5 GHz	--	--	--	0.040 deg rms	0.060 deg rms	0.150 deg rms
13.5 GHz to 20 GHz	--	--	--	0.040 deg rms	0.060 deg rms	0.150 deg rms
<b>Stability Magnitude</b>						
Stability is defined as a ratio measurement made at the test port.						
300 KHz to 10 MHz	--	--	--	+/-0.015 dB/°C		
10 MHz to 2 GHz	--	--	--	+/-0.010 dB/°C		
2 GHz to 4 GHz	--	--	--	+/-0.015 dB/°C		
4 GHz to 13.5 GHz	--	--	--	+/-0.020 dB/°C		
13.5 GHz to 16 GHz	--	--	--	+/-0.020 dB/°C		
16 GHz to 19 GHz	--	--	--	+/-0.025 dB/°C		
19 GHz to 20 GHz	--	--	--	+/-0.030 dB/°C		

Table 7. Test Port Input (Continued)						
Description	Specification			Typical		
	Options 140/240	Options 145/245	Options 146/246	Options 140/240	Options 145/245	Options 146/246
<b>Stability Phase</b>						
Stability is defined as a ratio measurement made at the test port.						
300 KHz to 10 MHz	--	--	--	+/-0.360°/°C		
10 MHz to 45 MHz	--	--	--	+/-0.020°/°C		
45 MHz to 500 MHz	--	--	--	+/-0.030°/°C		
500 MHz to 2 GHz	--	--	--	+/-0.050°/°C	+/-0.070°/°C	
2 GHz to 4 GHz	--	--	--	+/-0.100°/°C	+/-0.150°/°C	
4 GHz to 8 GHz	--	--	--	+/-0.150°/°C	+/-0.250°/°C	
8 GHz to 13.5 GHz	--	--	--	+/-0.300°/°C	+/-0.500°/°C	
13.5 GHz to 16 GHz	--	--	--	+/-0.300°/°C	+/-0.500°/°C	
16 GHz to 20 GHz	--	--	--	+/-0.350°/°C	+/-0.650°/°C	

Table 7. Test Port Input (Continued)				
Description	Specification		Typical	
	Options 140/240	Opt 145/146/245/246	Options 140/240	Opt 145/146/245/246
<b>Reference Level Magnitude</b>				
Range	+/-200 dB	+/-200 dB	--	--
Resolution	0.001dB	0.001dB	--	--
<b>Reference Level Phase</b>				
Range	+/-500°	+/-500°	--	--
Resolution	0.01°	0.01°	--	--

Table 7. Test Port Input (Continued)		
Damage Input Level	Typical Performance	
	Options 140/240	Opt 145/146/245/246
Test Port 1,2,3, and 4	+27 dBm or +/-16 VDC	+27 dBm or +/-16 VDC
Receivers R, A, B, C, D	--	+15 dBm or +/-16 VDC
Source out (reference)	--	+27 dBm or +/-16 VDC
Source out (test ports)	--	+27 dBm or +/-16 VDC
Coupler Thru	--	+27 dBm or +/-16 VDC
Coupler Arm	--	+15 dBm or +/-0 VDC

**Table 8. Dynamic Accuracy (Specification<sup>a</sup>)**

Accuracy of the test port input power reading relative to the reference input power level.

**Dynamic Accuracy, 0.045 GHz**

**Magnitude**

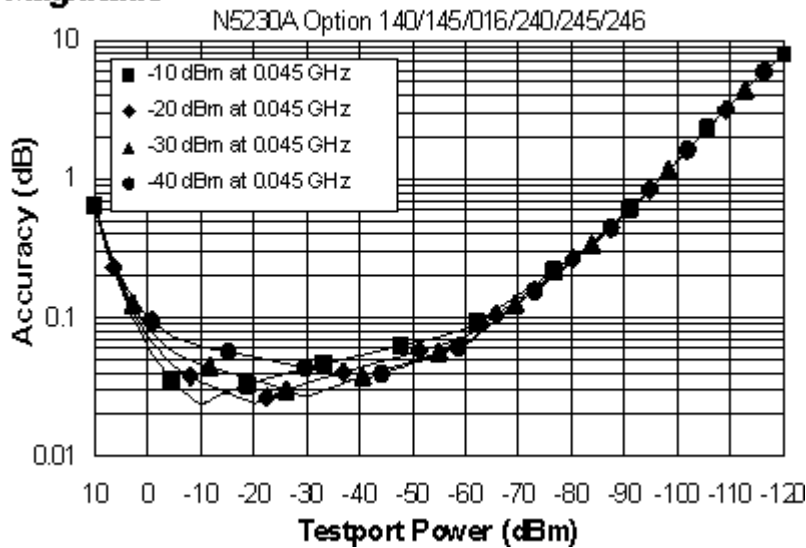

**Phase**

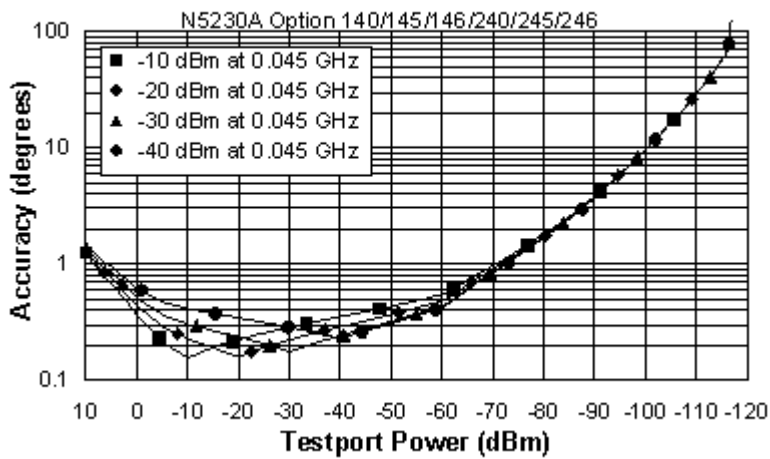

## Dynamic Accuracy, 0.500 GHz

### Magnitude

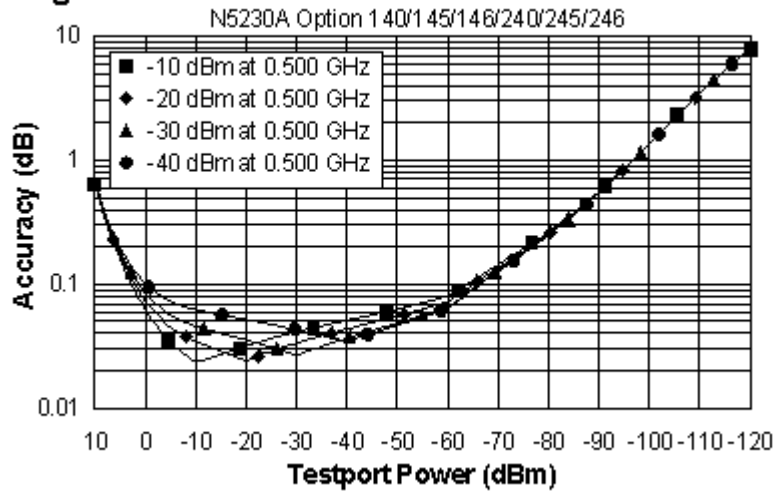

### Phase

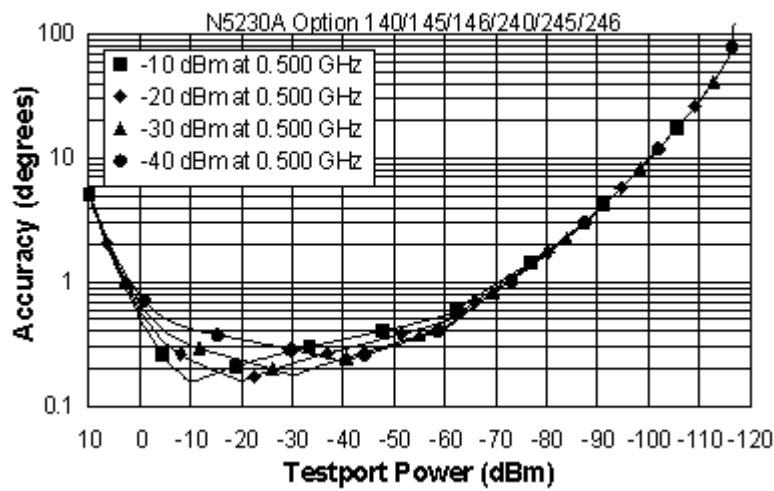

## Dynamic Accuracy, 1- 2 GHz

### Magnitude

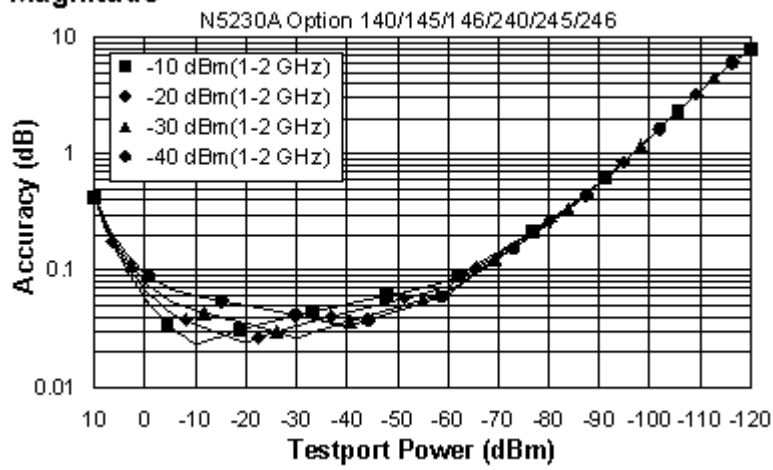

### Phase

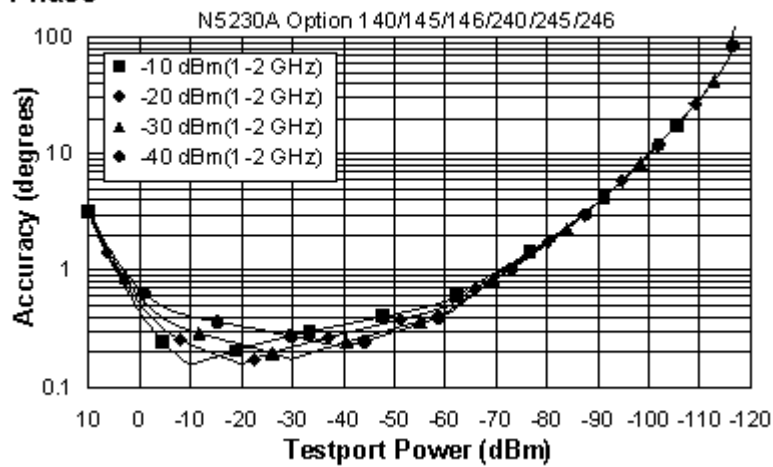



## Dynamic Accuracy, 2 - 12.5 GHz

### Magnitude

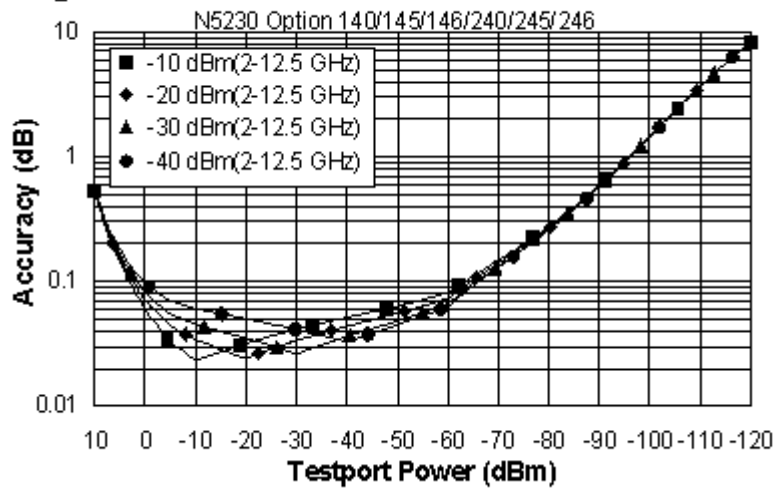

### Phase

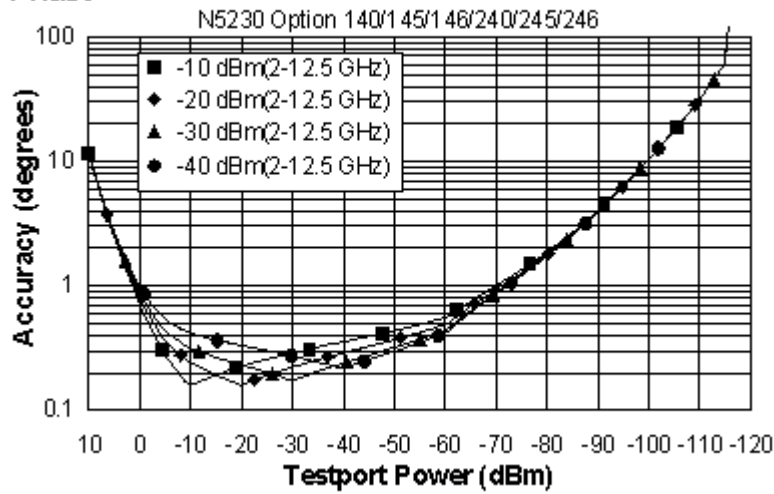

## Dynamic Accuracy, 12.5 – 13.5 GHz

### Magnitude

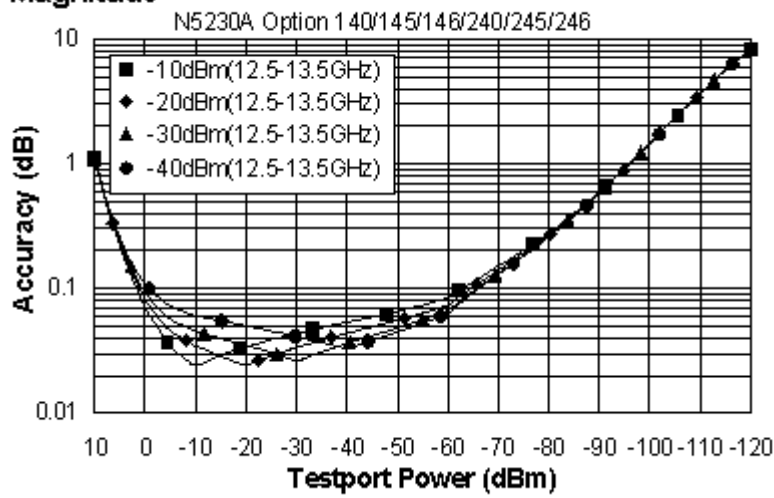

### Phase

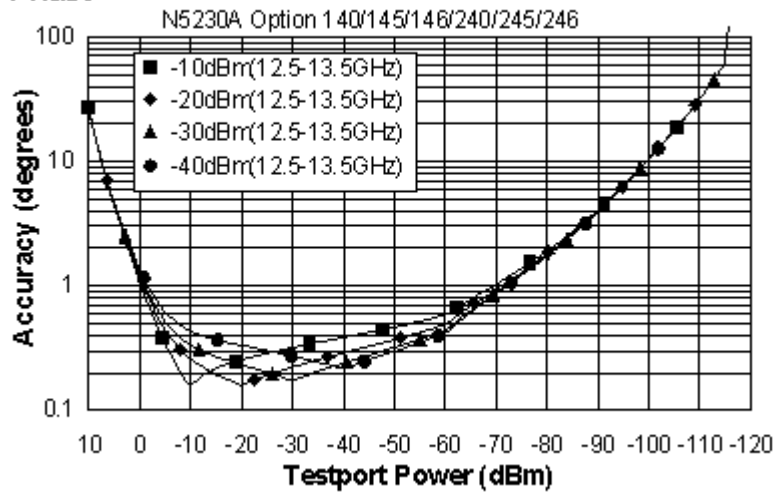

## Dynamic Accuracy, 13.5 - 20 GHz

### Magnitude

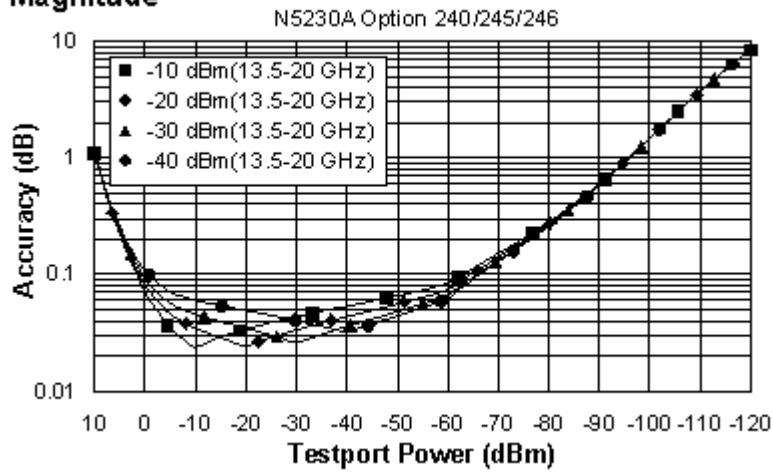

### Phase

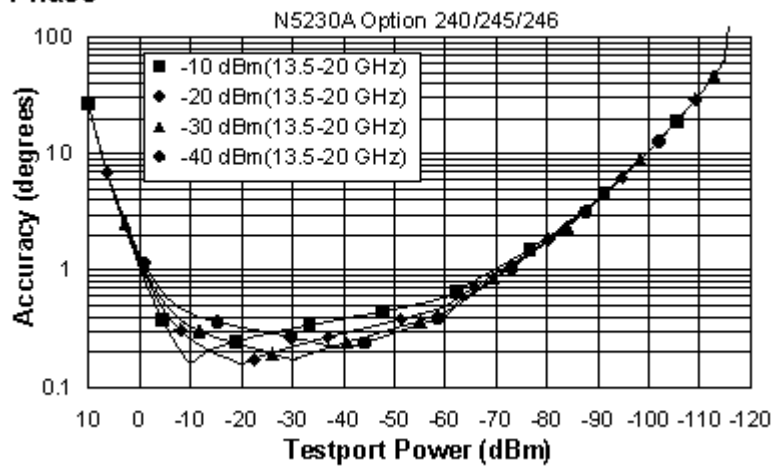

<sup>a</sup> Dynamic accuracy is verified with the following measurements:

- Compression over frequency
- IF linearity at a single frequency of 1.195 GHz using a reference level of -20 dBm for an input power range of 0 to -110 dBm.

**Table 9. Test Port Input (Group Delay)<sup>a</sup>**

Description	Supplemental Information (typ.)
Aperture (selectable)	(frequency span)/(number of points -1)
Maximum Aperture	20% of frequency span
Range	0.5 x (1/minimum aperture)
Maximum Delay	Limited to measuring no more than 180° of phase change within the minimum aperture.)
Accuracy	See graph below. Char.

The following graph shows characteristic group delay accuracy with full 2-port calibration and a 10 Hz IF bandwidth. Insertion loss is assumed to be < 2 dB and electrical length to be ten meters.

For any  $S_{ij}$  Group Delay measurement,  $S_{ii} = 0$ ,  $S_{ij} = 1$ ,  $S_{ji} = 0$ ,  $S_{kl} = 0$  for all  $kl \neq ij$

**Group Delay (Typical)**

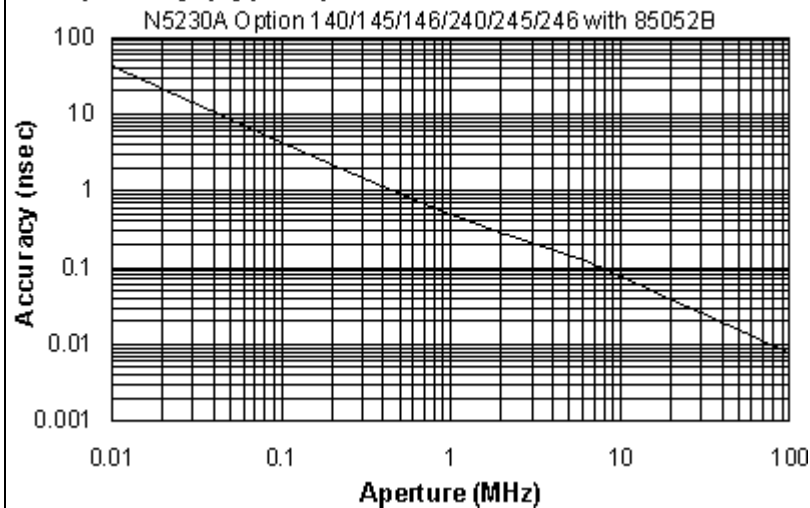

In general, the following formula can be used to determine the accuracy, in seconds, of specific group delay measurement:

$$\pm \text{Phase Accuracy (deg)} / [360 \times \text{Aperture (Hz)}]$$

Depending on the aperture and device length, the phase accuracy used is either incremental phase accuracy or worst-case phase accuracy.

<sup>a</sup> Group delay is computed by measuring the phase change within a specified frequency step (determined by the frequency span and the number of points per sweep).

## General Information

**Table 10. Miscellaneous Information**

Description	Supplemental Information
System IF Bandwidth Range	1 Hz to 600 kHz, nominal
CPU	Intel® 1.1 GHz Pentium® M with 1 GByte RAM

**Table 11. Front Panel Information**

Description	Supplemental Information
<b>RF Connectors</b>	
Type	Options 140/145/146/240/245/246: 3.5 mm (male), 50 ohm, (nominal)
Center Pin Recession	0.002 in. (characteristic)
<b>Display</b>	
NOTE: The PNA display must remain in the 16 bit color setting in order to comply with international emissions regulations.	
Size	21.3 cm (8.4 in) diagonal color active matrix LCD; 640 (horizontal) X 480 (vertical) resolution
Refresh Rate	Vertical 59.83 Hz; Horizontal 31.41 kHz
Pixels	When running the analyzer's built-in Display Test, one or more of the following symptoms indicate a faulty display assembly: <ul style="list-style-type: none"> <li>• A complete row or column of "stuck on" or "dark" pixels.</li> <li>• More than six "stuck on" pixels (but not more than three green)</li> <li>• More than twelve "dark" pixels (but not more than seven of the same color)</li> <li>• Two or more consecutive "stuck on" pixels or three or more consecutive "dark" pixels (but no more than one set of two consecutive 'dark' pixels)</li> <li>• "Stuck on" or "dark" pixels less than 6.5 mm apart (excluding consecutive pixels)</li> </ul>
<b>Display Range</b>	
Magnitude	±500 dB (at 20 dB/div), max
Phase	±500°, max
Polar	10 pUnits, min 1000 Units, max
<b>Display Resolution</b>	
Magnitude	0.001 dB/div, min
Phase	0.01°/div, min
<b>Marker Resolution</b>	
Magnitude	0.001 dB, min
Phase	0.01°, min
Polar	0.01 mUnit, min; 0.01°, min

**Table 12. Rear Panel Information**

Description	Supplemental Information
<b>10 MHz Reference In</b>	
Connector	BNC, female
Input Frequency	10 MHz $\pm$ 10 ppm, Typical
Input Level	-15 dBm to +20 dBm, Typical
Input Impedance	200 $\Omega$ , nom.
<b>10 MHz Reference Out</b>	
Connector	BNC, female
Output Frequency	10 MHz $\pm$ 1 ppm, Typical
Signal Type	Sine Wave, Typical
Output Level	+10 dBm $\pm$ 4 dB into 50 $\Omega$ , Typical
Output Impedance	50 $\Omega$ , nominal
Harmonics	<-40 dBc, Typical
<b>VGA Video Output</b>	
Connector	15-pin mini D-Sub; Drives VGA compatible monitors
<b>Devices Supported</b>	
<b>Resolutions:</b>	
Flat Panel (TFT)	1024 X 768, 800 X 600, 640 X 480
Flat Panel (DSTN)	800 X 600, 640 X 480
CRT Monitor	1280 X 1024, 1024 X 768, 800 X 600, 640 X 480
	Simultaneous operation of the internal and external displays is allowed, but with 640 X 480 resolution only. If you change resolution, you can only view the external display (internal display will "white out").
<b>Test Set IO</b>	
	25-pin D-Sub connector, female, available for external test set control
<b>Aux IO</b>	
	25-pin D-Sub connector, male, analog and digital IO
<b>Handler IO</b>	
	36-pin parallel I/O port; all input/output signals are default set to negative logic; can be reset to positive logic via GPIB command female.
<b>GPIB (two ports - dedicated controller and dedicated talker/listener)</b>	
	24-pin D-sub (Type D-24), female; compatible with IEEE-488.
<b>Parallel Port (LPT1)</b>	
	25-pin D-Sub miniature connector, female; provides connection to printers or any other parallel port peripherals
<b>Serial Port (COM 1)</b>	
	9-pin D-Sub, male; compatible with RS-232
<b>USB Port</b>	
	One port on front panel and five ports on rear panel. Universal Serial Bus jack, Type A configuration (4 contacts inline, contact 1 on left); female
Contact 1	Vcc: 4.75 to 5.25 VDC, 500 mA, maximum
Contact 2	-Data
Contact 3	+Data
Contact 4	Ground
<b>LAN</b>	
	10/100BaseT Ethernet, 8-pin configuration; auto selects between the two data rates
<b>Line Power</b> (A third-wire ground is required.)	
Frequency	50/60/400 Hz
Voltage at 115 V Setting	120/240 VAC (Power supply is auto switching)
Max	500 watts

**Note:** Option H08 and Option H11 are not available with the N5230A network analyzer.

**Table 13. Analyzer Environment and Dimensions**

Description	Supplemental Information		
<b>General Environmental</b>			
RFI/EMI Susceptibility	Defined by CISPR Pub. 11, Group 1, Class A, and IEC 50082-1		
ESD	Minimize using static-safe work procedures and an antistatic bench mat		
Dust	Minimize for optimum reliability		
<b>Operating Environment</b>			
Temperature	0 °C to +40 °C Instrument powers up and displays no error messages within this temperature range (except for "source unlevelled" error message that may occur at temperatures outside the specified performance temperature range of 25 +/- 5°C).		
Error-Corrected Temperature Range	23°C ± 3°C with less than 1°C deviation from calibration temp.		
Humidity	5% to 95% at +40 °C		
Altitude	0 to 4500 m (14,760 ft.)		
<b>Non-Operating Storage Environment</b>			
Temperature	-40 °C to +70 °C		
Humidity	0% to 90% at +65 °C (non-condensing)		
Altitude	0 to 4500 m (14,760 ft.)		
<b>Cabinet Dimensions</b>			
	Height	Width	Depth
Excluding front and rear panel hardware and feet	267 mm 10.5 in	426 mm 16.75 in	427 mm 16.8 in
As shipped - includes front panel connectors, rear panel bumpers, and feet.	280 mm 11.0 in	435 mm 17.1 in	470 mm 18.5 in
As shipped plus handles	280 mm 11.0 in	458 mm 18 in	501 mm 19.7 in
As shipped plus rack-mount flanges	280 mm 11.0 in	483 mm 19 in	470 mm 18.5 in
As shipped plus handles and rack-mount flanges	280 mm 11.0 in	483 mm 19 in	501 mm 19.70 in
<b>Weight</b>			
<b>Net</b>	24.9 kg (55 lb), nominal		
<b>Shipping</b>	36.3 kg (80 lb), nominal		

## Measurement Throughput Summary

**Table 14** Typical Cycle Time<sup>a</sup> (ms) for Measurement Completion

Description	Typical Performance									
	Options 140/145/240/245					Options 146/246				
	Number of Points									
	201	401	801	1601	16,001	201	401	801	1601	16,001
<b>Start 8 GHz, Stop 18 GHz, 600 kHz IF bandwidth</b>										
Uncorrected	21.148	21.743	23.01	25.198	54.836					
4-Port cal	74.597	82.296	296.5	307.75	538.646					
<b>Start 300 kHz, Stop 10 GHz, 600 kHz IF bandwidth</b>										
Uncorrected	19.814	22.801	24.973	29.01	67.733					
4-Port cal	69.752	85.111	100.125	129.347	480.711					
<b>Start 300 kHz, Stop 20 GHz, 600 kHz IF bandwidth</b>										
Uncorrected	32.575	34.7	39.237	43.155	69.625					
4-Port cal	121.254	133.626	157.506	179.223	487.779					
<b>Start 8 GHz, Stop 18 GHz, 100 kHz IF bandwidth</b>										
Uncorrected	38.083	51.816	55.488	56.36	184.154					
4-Port cal	143.271	201.814	215.056	230.133	934.161					
<b>Start 300 kHz, Stop 10 GHz, 100 kHz IF bandwidth</b>										
Uncorrected	37.03	42.532	45.122	46.729	198.683					
4-Port cal	137.431	162.37	194.13	192.182	906.768					
<b>Start 300 kHz, Stop 20 GHz, 100 kHz IF bandwidth</b>										
Uncorrected	44.98	69.408	87.161	92.475	198.792					
4-Port cal	169.041	268.877	343.898	369.526	914.963					
<b>Start 8 GHz, Stop 18 GHz, 50 kHz IF bandwidth</b>										
Uncorrected	42.171	70.09	88.702	90.981	371.611					
4-Port cal	157.107	271.791	351.517	368.02	1532.609					
<b>Start 300 kHz, Stop 10 GHz, 50 kHz IF bandwidth</b>										
Uncorrected	43.713	61.41	66.878	69.373	385.04					
4-Port cal	163.58	238.267	259.687	279.816	1580.761					
<b>Start 300 kHz, Stop 20 GHz, 50 kHz IF bandwidth</b>										
Uncorrected	48.673	80.798	124.605	147.303	388.46					
4-Port cal	184.429	313.392	493.142	587.548	1587.839					

<sup>a</sup> Includes sweep time, retrace time and band-crossing time. Analyzer display turned off with DISPLAY:ENABLE OFF. Add 21 ms for display on. Data for one trace (S<sub>11</sub>) measurement.



**Table 15. Cycle Time vs. IF Bandwidth, Options 140/145/240/245**

Applies to the Preset condition (201 points, correction off) except for the following changes:

- CF = 10 GHz
- Span = 100 MHz
- Test Port Power = 6 dBm
- Display off (add 21 ms for display on)

Description	Typical Performance	
	IF Bandwidth (Hz)	Cycle Time (ms) <sup>a</sup>
600,000	3.13	0.00544
360,000	3.21	0.00602
280,000	3.17	0.00321
200,000	3.17	0.00259
150,000	3.19	0.00207
100,000	4.05	0.00155
70,000	4.99	0.00144
50,000	6.41	0.00121
30,000	8.78	0.00094
20,000	12.07	0.00080
15,000	14.91	0.00069
10,000	26.02	0.00052
7000	34.54	0.00047
5000	45.87	0.00044
3000	69.91	0.00032
2000	99.69	0.00029
1500	128.18	0.00010
1000	215.62	0.00009
700	291.58	0.00006
500	397.36	0.00007
300	633.86	0.00000
200	930.15	0.00000
100	1824.19	0.00000
30	6001.70	0.00000
10	17899.79	0.00000
1	178391.58	0.00000

<sup>a</sup> Cycle time includes sweep and retrace time.

**Table 16. Cycle Time vs. Number of Points, Options 140/145/240/245**

Applies to the Preset condition (correction off) except for the following changes:

- CF = 10 GHz
- Span = 100 MHz
- Test Port Power = 7 dBm
- Display off (add 21 ms for display on)

Description	Typical Performance	
	Number of Points	Cycle Time (ms) <sup>a</sup>
30,000 (Hz)	3	2.88
	11	3.50
	51	3.91
	101	5.29
	201	8.75
	401	15.66
	801	29.46
	1,601	57.73
	6,401	221.04
	16,001	549.71
100,000	3	2.87
	11	2.82
	51	2.86
	101	2.96
	201	4.02
	401	6.23
	801	10.65
	1,601	19.49
	6,401	70.96
	16,001	173.78
600,000	3	2.84
	11	2.84
	51	2.87
	101	3.03
	201	3.14
	401	3.51
	801	4.22
	1,601	6.22
	6,401	19.35
	16,001	45.12

<sup>a</sup> Cycle time includes sweep and retrace time.

**Table 17. Data Transfer Time (ms)**

Description	Typical Performance			
	Number of Points			
	201	401	1601	16,001
<b>SCPI over GPIB</b>				
<b>(Program executed on external PC)</b>				
32-bit floating point	6	10	33	313
64-bit floating point	10	18	65	622
ASCII	53	105	406	4032
<b>SCPI over SICL/LAN or TCP/IP Socket</b>				
<b>(Program executed in the analyzer)</b>				
32-bit floating point	1	2	205	7
64-bit floating point	2	2	3	10
ASCII	11	20	73	720
<b>COM (program executed in the analyzer)</b>				
32-bit floating point	<0.2	0.2	0.3	0.9
Variant type	0.6	1	3.2	32
<b>DCOM over LAN</b>				
<b>(Program executed on external PC)</b>				
32-bit floating point	<0.8	1	1.6	7.5
Variant type	1.9	3	8.9	82

---

**Note:** Specifications for Recall & Sweep Speed are not provided for the N5230A analyzers.

---

## Specifications: Front-Panel Jumpers

### Model N5230A Option 145/146/245/246

**Table 18:** Measurement Receiver Inputs (Rcvr A In, Rcvr B In, Rcvr C In, Rcvr D In) 0.1dB Typical Compression

Description	Specification	Typical
		Opt 145/146/245/246
<b>Maximum Input Level</b>		
300 kHz to 10 MHz	--	- 11 dBm
10 MHz to 1 GHz	--	- 7 dBm
1 GHz to 12.5 GHz	--	- 6 dBm
12.5 GHz to 13.5 GHz	--	- 7 dBm
13.5 GHz to 20 GHz	--	- 7 dBm
<b>Damage Level</b>		
N5230A	--	+ 15 dBm
<b>Maximum DC Level</b>		
N5230A	--	+/- 16 V

**Table 19:** Reference Receiver Input (Rcvr In) @ Max Specified Output Power

Description	Specification	Typical	
		Option 145, 245	Option 146, 246
<b>Maximum Input Level</b>			
300 kHz to 10 MHz	--	- 18 dBm	- 28 dBm
10 MHz to 45 MHz	--	- 15 dBm	- 25 dBm
45 MHz to 500 MHz	--	- 15 dBm	- 25 dBm
500 MHz to 4 GHz	--	- 15 dBm	- 26 dBm
4 GHz to 6 GHz	--	- 16 dBm	- 27 dBm
6 GHz to 10.5 GHz	--	- 20 dBm	- 30 dBm
10.5 GHz to 13.5 GHz	--	- 21 dBm	- 32 dBm
13.5 GHz to 15 GHz	--	- 21 dBm	- 32 dBm
15 GHz to 20 GHz	--	- 27 dBm	- 38 dBm
<b>Damage Level</b>			
N5230A	--	+ 15 dBm	+ 15 dBm
<b>Maximum DC Level</b>			
N5230A	--	+/- 16 V	+/- 16 V

**Table 20: Reference Output (Source Out) @ Max Specified Output Power**

Description	Specification	Typical	
		Opt 145/245	Opt 146/246
<b>Maximum Output Level</b>			
300 kHz to 10 MHz	--	- 18 dBm	- 28 dBm
10 MHz to 45 MHz	--	- 15 dBm	- 25 dBm
45 MHz to 500 MHz	--	- 15 dBm	- 25 dBm
500 MHz to 4 GHz	--	- 15 dBm	- 26 dBm
4 GHz to 6 GHz	--	- 15 dBm	- 26 dBm
6 GHz to 10.5 GHz	--	- 20 dBm	- 30 dBm
10.5 GHz to 13.5 GHz	--	- 21 dBm	- 32 dBm
13.5 GHz to 15 GHz	--	- 21 dBm	- 32 dBm
15 GHz to 20 GHz	--	- 27 dBm	- 38 dBm
<b>Damage Level</b>			
N5230A	--	+ 27 dBm	+ 27 dBm
<b>Maximum DC Level</b>			
N5230A	--	+/- 16 V	+/- 16 V

**Table 21: Source Outputs (Port 1 Source Out, Port 2 Source Out, Port 3 Source Out, Port 4 Source Out) @ Max Specified Output Power**

Description	Specification	Typical
		Opt 145/146/245/246
<b>Maximum Output Level</b>		
300 kHz to 10 MHz	--	+7 dBm
10 MHz to 45 MHz	--	+ 10 dBm
45 MHz to 500 MHz	--	+ 10 dBm
500 MHz to 4 GHz	--	+ 10 dBm
4 GHz to 6 GHz	--	+ 9 dBm
6 GHz to 10.5 GHz	--	+ 4 dBm
10.5 GHz to 13.5 GHz	--	+ 1 dBm
13.5 GHz to 15 GHz	--	+ 1 dBm
15 GHz to 20 GHz	--	- 4 dBm
<b>Damage Level</b>		
N5230A	--	+ 27 dBm
<b>Maximum DC Level</b>		
N5230A	--	+/- 16V

**Table 22: Coupler Inputs (Port 1 Cplr Thru, Port 2 Cplr Thru, Port 3 Cplr Thru, Port 4 Cplr Thru)  
Insertion Loss of Coupler Thru**

Description	Specification	Typical
		Opt 145/146/245/246
<b>Insertion Loss to Test Port</b>		
300 kHz to 10 MHz	--	1.5 dB
10 MHz to 45 MHz	--	1.5 dB
45 MHz to 500 MHz	--	1.5 dB
500 MHz to 4 GHz	--	2.0 dB
4 GHz to 6 GHz	--	2.5 dB
6 GHz to 10.5 GHz	--	2.5 dB
10.5 GHz to 13.5 GHz	--	3.0 dB
13.5 GHz to 15 GHz	--	3.0 dB
15 GHz to 20 GHz	--	3.0 dB
<b>Damage Level</b>		
N5230A	--	+ 27 dBm
<b>Maximum DC Level</b>		
N5230A	--	+/- 16 V

**Table 23: Coupler Outputs (Port 1 Cplr Arm, Port 2 Cplr Arm, Port 3 Cplr Arm, Port 4 Cplr Arm)**

Description	Specification	Typical
		Opt 145/146/245/246
<b>Damage Level</b>		
N5230A	--	+ 15 dBm
<b>Maximum DC Level</b>		
N5230A	--	0 V

Test Set Block Diagrams

N5230A Option 140 or 240 Standard Test Set and Standard Power Range

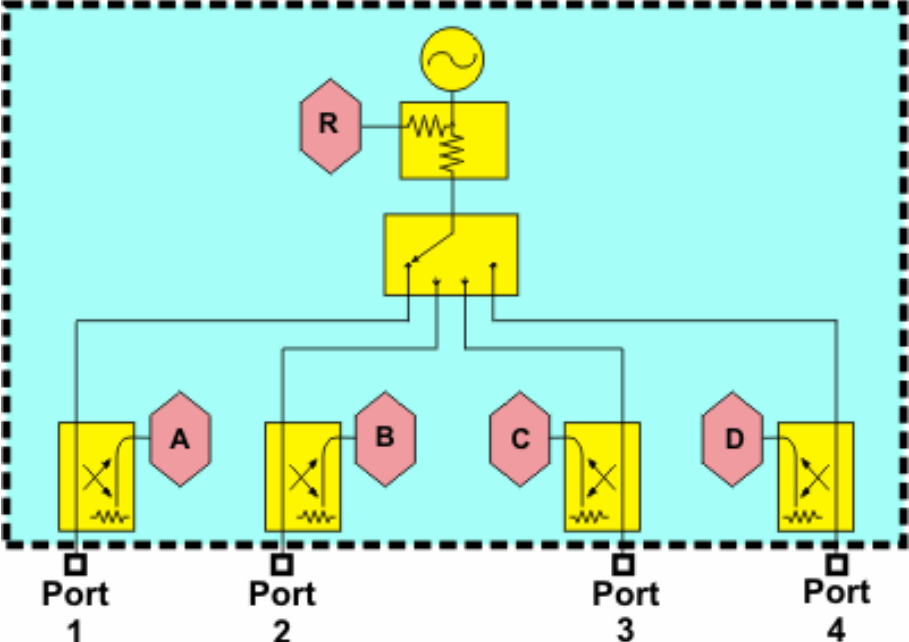

**N5230A Option 145 or 245 Configurable Test Set and Extended Power Range**

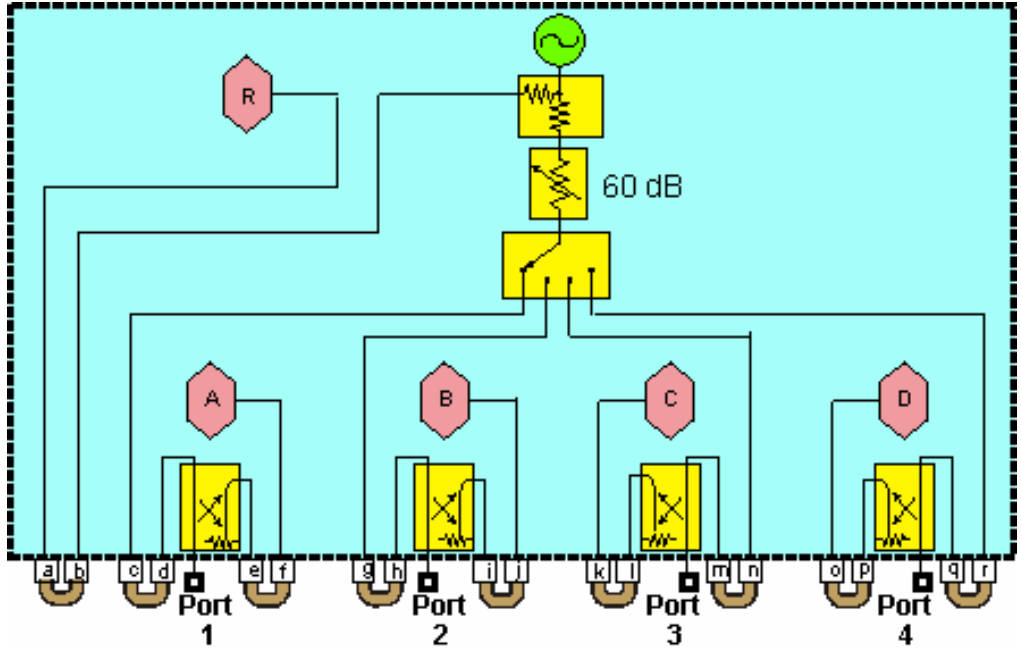

Item	Description	Item	Description	Item	Description
a	RCVR R IN	h	CPLR THRU	o	RCVR D IN
b	SOURCE OUT	i	CPLR ARM	p	CPLR ARM
c	SOURCE OUT	j	RCVR B IN	q	CPLR THRU
d	CPLR THRU	k	RCVR C IN	r	SOURCE OUT
e	CPLR ARM	l	CPLR ARM		
f	RCVR A IN	m	CPLR THRU		
g	SOURCE OUT	n	SOURCE OUT		



N5230A Option 146 or 246 Configurable Test Set and Extended Power Range

